

VEVOR[®]

TOUGH TOOLS, HALF PRICE

DRYWALL SANDER OPERATING MANUAL

Model: WS225-KCL

We continue to be committed to provide you tools with competitive price. "Save Half", "Half Price" or any other similar expressions used by us only represents an estimate of savings you might benefit from buying certain tools with us compared to the major top brands and does not necessarily mean to cover all categories of tools offered by us. You are kindly reminded to verify carefully when you are placing an order with us if you are actually saving half in comparison with the top major brands.

Model: WS225-KCL

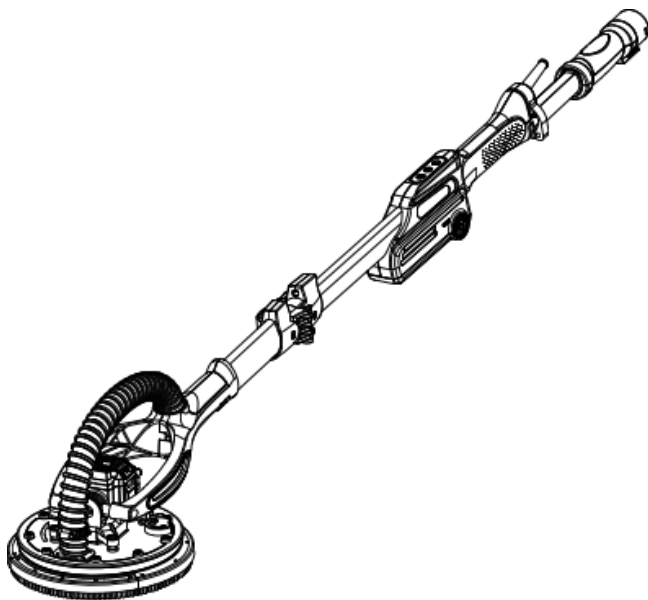

NEED HELP? CONTACT US!

Have product questions? Need technical support? Please feel free to contact us:

✉ CustomerService@vevor.com

This is the original instruction, please read all manual instructions carefully before operating. VEVOR reserves clear interpretation of our user manual. The appearance of the product shall be subject to the product you received. Please forgive us that we won't inform you again if there are any technology or software updates on our product.

1. PRODUCT DESCRIPTION

The machine is designed for sanding dry walls, ceilings and walls of the inner and outer surface clearing the floor residues, paint coatings, adhesive and loose plaster etc.

Our machine is not suitable for processing the object containing asbestos.



You must abide by certain safety precautions when using the equipment. In order to prevent injuries and damages from occurring, you must always read through this operating manual carefully.

This manual must be kept in a safe place so that the information that it contains is always available. This operating manual must accompany the equipment if it is transferred to somebody else.

We do not accept any liability for accidents or damage arising from ignoring this manual and the safety instructions.

2. SPECIFICATIONS

| | |
|-----------------------|--------------|
| Model No. | WS225-KCL |
| Power | 850W |
| No Load Speed | 1000-2300rpm |
| Grinding pad diameter | 9inch |
| Sandpaper diameter | 225mm |
| Tube diameter | 32mm |
| Weight | 3.4KG |
| Protection class | □ / II |

3. SAFETY INSTRUCTIONS

The following pictograms appear throughout these operating instructions:



Indicates danger of injury, risk to life and possible damage to the appliance if these instructions are not followed.



Indicates the presence of electric shocks.

Read through these operating instructions carefully before using the appliance. Become familiar with the functions and method of operation. To ensure proper operation, always maintain the appliance according to the instructions. The operating instructions and associated documents should always be kept close to the appliance.

When using power tools, you must observe the following basic safety precautions in order to ensure protection from electric shocks, injury and fire. Read and follow all the instructions before using this power tool. Look after the notes on safety.



Always check if your mains voltage corresponds with the value on the type plate.



The machine has been double-insulated in accordance with EN60745: therefore, an earth wire is not necessary

USE CORRECT SUPPLY VOLTAGE: The power supply voltage must match the information quoted on the tools identification plate .

USE PROPER EXTENSION CORD: Only use an approved extension cable that is suitable for the machine's power. The cord must have a diameter of at least 1.5mm². When the extension cable is on a reel, unroll the cable in its entirety

SWITCH OFF THE MACHINE IMMEDIATELY IN CASE OF:

1. Malfunction in the mains plug, power cable or damaging of cable.
2. Broken switch.
3. Smoke or stench of scorched insulation.

4. GENERAL SAFETY RULES



WARNING! Read all safety warnings and all instructions.

Failure to follow the warnings and instructions may result in electric shock, fire and/or serious injury .

Save all warnings and instructions for future reference .

The term "power tool" in the warnings refers to your mains-operated (corded) power tool or battery-operated (cordless) power tool.

1) Work area safety.

a) **Keep work area clean and well lit** . Cluttered or dark areas invite accidents .

b) **Do not operate power tools in explosive atmospheres, such as in the presence of flammable liquids, gases or dust** . Power tools create sparks which may ignite the dust or fumes .

c) **Keep children and bystanders away while operating a power tool.** Distractions can cause you to lose control.

2) Electrical safety

a) Power tool plugs must match the outlet. Never modify the plug in any way. Do not use any adapter plugs with earthed (grounded) power tools. Unmodified plugs and matching outlets will reduce risk of electric shock.

b) Avoid body contact with earthed or grounded surfaces, such as pipes, radiators, ranges and refrigerators. There is an increased risk of electric shock if your body is earthed or grounded .

c) Do not expose power tools to rain or wet conditions. Water entering a power tool will increase the risk of electric shock.

d) Do not abuse the cord. Never use the cord for carrying, pulling or unplugging the power tool. Keep

cord away from heat, oil, sharp edges or moving parts .

Damaged or entangled cords increase the risk of electric shock .

e) When operating a power tool outdoors, use an extension cord suitable for outdoor use.(Use of a cord suitable for outdoor use reduces the risk of electric shock.

f) If operating a power tool in a damp location is unavoidable, use a residual current device (RCD) protected supply. Use of an RCD reduces the risk of electric shock.

3) Personal safety

a) Stay alert, watch what you are doing and use common sense when operating a power tool. Do not use a power tool while you are tired or under the influence of drugs, alcohol or medication. A moment of

inattention while operating power tools may result in serious personal injury.

b) Use personal protective equipment. Always wear eye protection. Protective equipment such as dust mask, non-skid safety shoes, hard hat, or hearing protection used for appropriate conditions will reduce personal injuries.

c) Prevent unintentional starting. Ensure the switch is in the off-position before connecting to power source and/or battery pack, picking up or carrying the tool. Carrying power tools with your finger on the switch or energizing power tools that have the switch on invites accidents.

d) Remove any adjusting key or wrench before turning the power tool on. A wrench or a key left attached to a rotating part of the power tool may result in personal injury.

e) Do not overreach. Keep proper footing and balance at all times. This enables better control of the power tool in unexpected situations.

f) Dress properly. Do not wear loose clothing or jewellery. Keep your hair, clothing and gloves away from moving parts. Loose clothes, jewellery or long hair can be caught in moving parts.

g) If devices are provided for the connection of dust extraction and collection facilities, ensure these are connected and properly used. Use of dust collection can reduce dust-related hazards.

4) Power tool use and care

a) Do not force the power tool. Use the correct power tool for your application. The correct power tool will do the job better and safer at the rate for which it was designed.

b) Do not use the power tool if the switch does not turn it on and off. Any power tool that cannot be controlled with the switch is dangerous and must be repaired.

c) Disconnect the plug from the power source and/or the battery pack from the power tool before making any adjustments, changing accessories, or storing power tools. Such preventive safety measures reduce the risk of starting the power tool accidentally

d) Store idle power tools out of the reach of children and do not allow persons unfamiliar with the power tool or these instructions to operate the power tool. Power tools are dangerous in the hands of untrained users.

e) Maintain power tools. Check for misalignment or binding of moving parts,

breakage of parts and any other condition that may affect the power tool's operation. If damaged, have the power tool repaired before use. Many accidents are caused by poorly maintained power tools. f) Keep cutting tools sharp and clean. Properly maintained cutting tools with sharp cutting edges are less likely to bind and are easier to control.

g) Use the power tool, accessories and tool bits etc. in accordance with these instructions, taking into account the working conditions and the work to be performed. Use of the power tool for operations different from those intended could result in a hazardous situation.

5) Service

a) Have your power tool serviced by a qualified repair person using only identical replacement parts. This will ensure that the safety of the power tool is maintained.

5. PRECAUTIONS ON USING DRYWALL SANDER

Attention! You must abide by the following basic safety measures against electrical shocks, injuries and the danger of fire when using electric tools. Read and abide by these instructions before you start to use any tools. These instructions must be kept in a safe place.

-- The equipment must never be used in surroundings where an explosive atmosphere exists. Do not let the cable touch any parts of your body.

-- Only use the extension cable approved for use in the working area.

-- Do not force the machine for unsuitable work, for example, rough grinding, brushing, etc. Otherwise dangers and harms will be caused.

-- Only use identical replacement parts when servicing. Otherwise, risk-free operation can't be guaranteed.

- The accessories' allowed speed must be at least the same as the maximum speed of the machine. Or else, they may be broken or cracked when their running speed is go over the machine's allowed speed.
- Do not use damaged accessories. Before use, always check whether the accessories are nicked or cracked. For example, to grinding pad, please check the support plate is not cracked. Ensure everybody to be out of the machine's rotation area and run the machine at max.speed for one minute, which can fully test the accessories.
- Do not put down the machine when it isn't stopped completely. Otherwise, you will loss control to the machine.
- Cleaning the exhaust port on your machine in regular. When working, control the machine firmly with both hands to ensure safe operation.
- When sanding, do not use too big sandpaper.When choosing grinding disc, please observe the manufacturer's specifications. The sand paper beyond the grinding block leads to risk of cutting and injury and cause stuck as well.
- The machine can be connect to one extension tubes at most.
- We recommend that you always wear industrial safety gloves and safety goggles when working with the drywall sander.
- Wearing close-fitting clothes is mandatory.
- Always allow for reaction torque.
- Wear protection mask P2 to protect you from hazardous dusts and choose suitable vacuum cleaner.

6. HOW TO USE DRYWALL SANDER



Before setting up, repair or maintenance of the appliance you must always turn off the operating switch and pull out the mains plug!

Before Initial Operation

- Check if the rated frequency of the mains supply corresponds to the details of the type place.
- Before using the tool, read the instruction book carefully.

6.1 Fold function

Adjust Screw with screwdriver first, then the lock wrench directly buckle in

place.

1-1

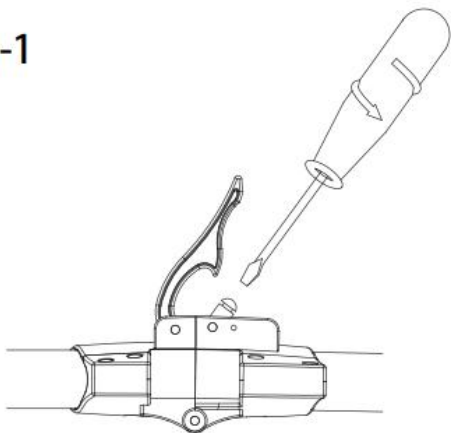

1-2

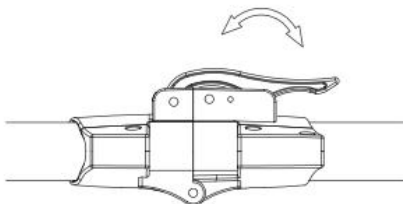

6.2 How to Operate

-- Loosen the lock spanner, take the extension rod to connect with machine [1-3].

1-3

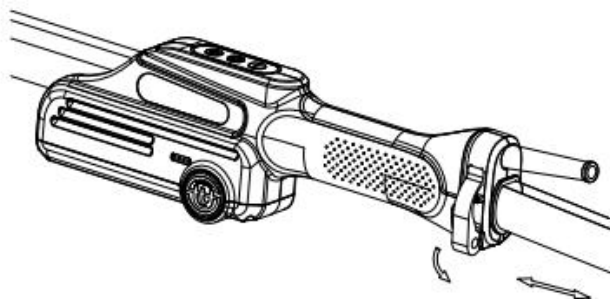

-- Take the dust hose to connect with the extension rod [1-4].

1-4

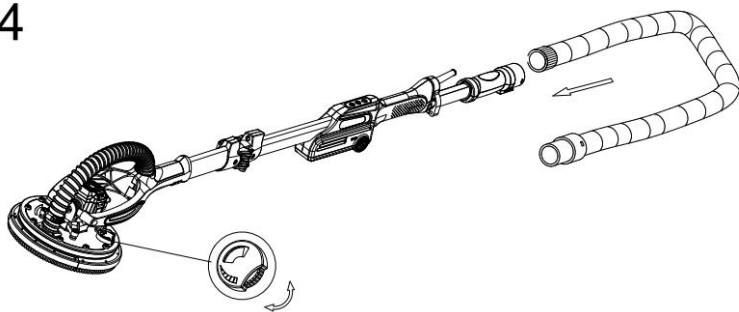

6.3 Electronic Control

This machine has the characteristics as below:

-- Lock-on switch [1-5];

1-5

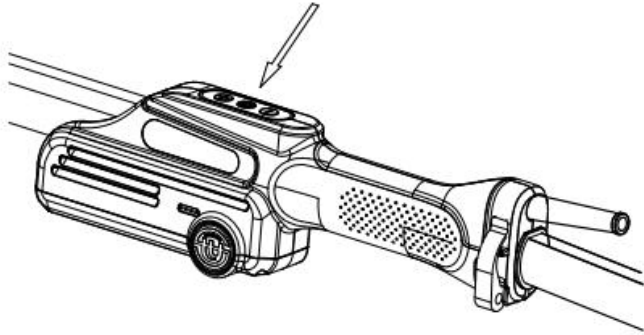

--Adjustable Speed [1-6]

Adjust the speed from 1000-2300 rpm by turning the speed wheel [1-6]. In this way, user can choose different speed for different sanding surface.

1-6

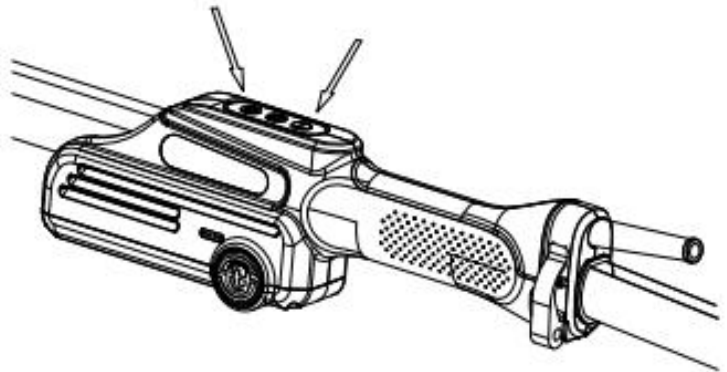

6.4 Replace Sanding Pad [1-7]

-- Insert the hex wrench (size 5) into the hexagonal screw bolt on the sanding pad.

-- Hold the sanding pad firmly, and then turn the wrench to dismount the pad.

-- Install new sanding pad by tightening the bolt

1-7

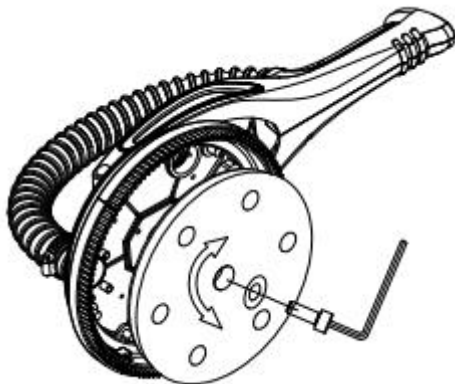

Attention: Only install the specified sanding pad on the machine.

6.5 Stick the Sanding Paper to the Pad [1-8]

Please ensure the holes on the sanding paper to fit the holes on the pad accurately.

1-8

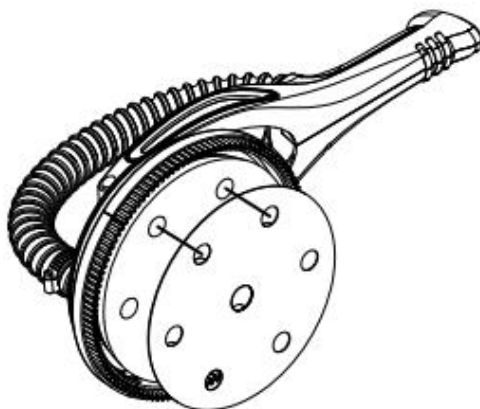

6.6 Suction power adjustment [1-9]

Clockwise to reduce suction power, counter-clockwise to increase suction power.

1-9

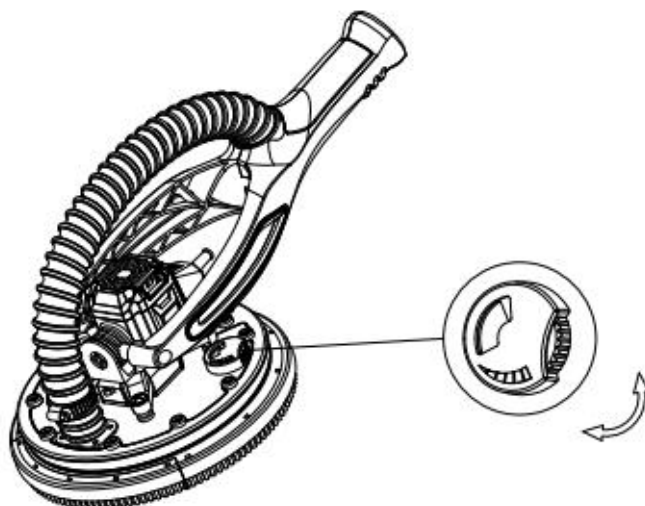

6.7 Grinding Adjacent Edges [1-10]

Detachable brush segment can reach up to the adjacent edge with ease.



1-10

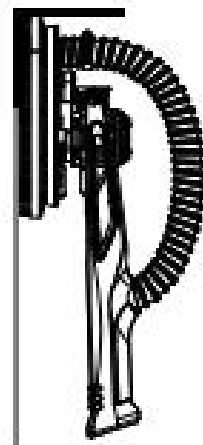

6.8 To sand the ceil [1-11]

The grinding machine head lifted, tensile spring hook head, so that the grinding easier

1-11

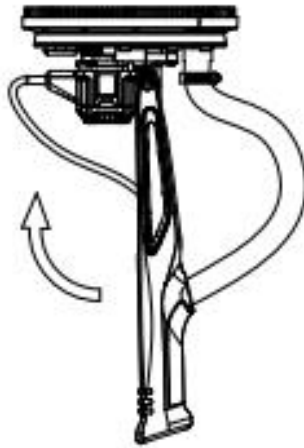

6.9 To change the dust hose.

-- Loosen the hoop by the screwdriver, take out the dust hose [1-12].

1-12



-- Counterclockwise rotation of the dust hose [1-13]

1-13

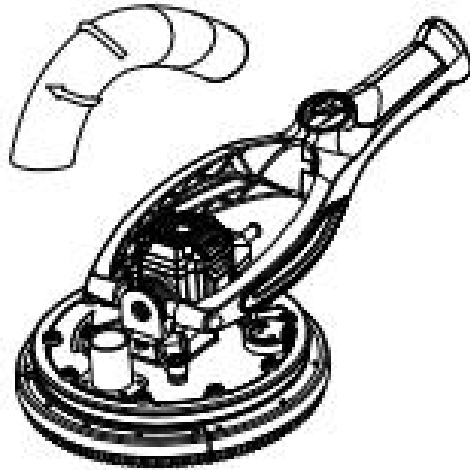

6.10 Disassemble the extension rod [1-14]

When disassemble the extension rod, pls must press the limited knob, then take out the extension rod.

1-14

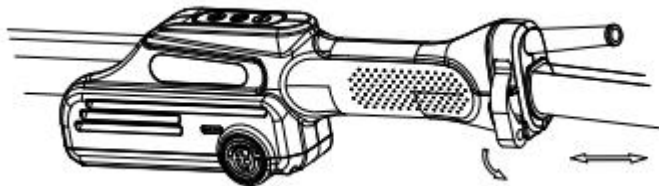

7. Operate the Machine

- Do not control the machine's head.
- Hold the machine with both hands.
- Before operating the machine, make sure every fastening handle is closed.
- Connect the machine to the main power supply.
- Before switching on the machine, keep the sanding head slightly away from the work surface.

- Start the machine for necessary sanding work.
 - Operate the machine with short length in narrow and awkward area.
 - Run the machine with medium length for higher walls.
 - Use the machine with longest length for ceilings.
- Do not over-press machine so that to avoid overloading! Press with proper pressure for better grinding effects. Good grinding effects and quality are mainly decided by choosing the right abrasive material.
- Once finishing the sanding task, switch off the machine.

8. CARE AND MAINTENANCE

Remove the plug from the socket before carrying out any adjustment, servicing or maintenance.

Your power tool requires no additional lubrication or maintenance. Always store your power tool in a dry place.

If the supply cord is damaged, it must be replaced by the manufacturer, its service agent or similarly qualified persons in order to avoid a hazard. If a fault can not be rectified, return the mixer to an authorized dealer for repair.

Cleaning

Keep the safety devices, ventilation slots and Motor housing as free of dirt and dust as possible. Clean the unit by rubbing it with a clean cloth or blow it clean using low-pressure compressed air.

- We recommend that you always clean the unit immediately after using it.
- Clean the unit regularly by rubbing it with a damp cloth and a little soft soap. Do not use cleaners or solvent these will attack the plastic parts in the unit. You must also ensure that water cannot get into the inside of the unit.

Carbon brushes

- If excessive sparking occurs you must have the carbon brushes checked by a qualified electrician. Attention! Only a qualified electrician is allowed to change the brushes.

9. CORRECTIVE ACTION IN CASE OF FAILURE

- (1) The operating switch is switched on, but the motor is not working.
 - Wires in the mains plug or in the socket are loose.
 - Have socket and plug checked or repaired.

-- The switch is faulty.
Have the switch replaced.

(2) The operating switch is switched on, but unusual noises can be heard, the motor is not working or only very slowly.

-- Switch contact has failed.
Have the switch replaced.

-- Component jammed.
Have the electric tool checked or repaired.

-- Too much thrust, as a result the motor is dragging.
Use less thrust during the task.

(3) Motor gets hot.

-- Foreign substances have got inside the motor.
Have the foreign substances removed.

-- Lack of or contaminated lubrication grease.
Have lubricating grease applied or replaced.

-- Pressure too high
Use less thrust during the task

(4) Frequent or strong sparks on the commutator.

-- Short circuit on the armature.
Have the armature replaced.





-- Carbon brushes worn out or jammed
Have the carbon brushes checked.

-- Rough running of the commutator.
Have the surface of the commutator cleaned or ground.

For your own safety, never remove parts or accessories of the electric tool during operation. In case of fault or damage have the electric tool repaired only by a specialist workshop or by the manufacturer.

10. LABELS ON YOUR TOOL (if any)

| | | | |
|----------------|---------------------|---------------------------|---|
| V | Volts | Hz | Hertz |
| ~ | Alternating current | W | Watts |
| n _o | No load speed | /min or min ⁻¹ | Revolutions or reciprocation per minute |

| | | | |
|--|---------------------|---|---|
|  | Class II tool |  | To reduce the risk of injury, user must read instruction manual |
|  | Wear Ear Protection |  | Wear Eye Protection |

 For your personal safety, READ and UNDERSTAND before using. Save This Instruction For Future Reference

 Always Wear Ear Protection With This Tool

 Always Wear Eye Protection With This Tool

 Always Wear a breathing Mask With This Tool

 This device complies with Part 15 of the FCC Rules. Operation is subject to the following two conditions: (1) This device may not cause harmful interference, and (2) this device must accept any interference received, including interference that may cause undesired operation.

Manufacturer: Ningbo Haq Tool Co.,Ltd

Address: No. 8 Jinfeng Road, Econbmic Development Zone, Yuyao City, Zhejiang, P.R.China.

Made In China

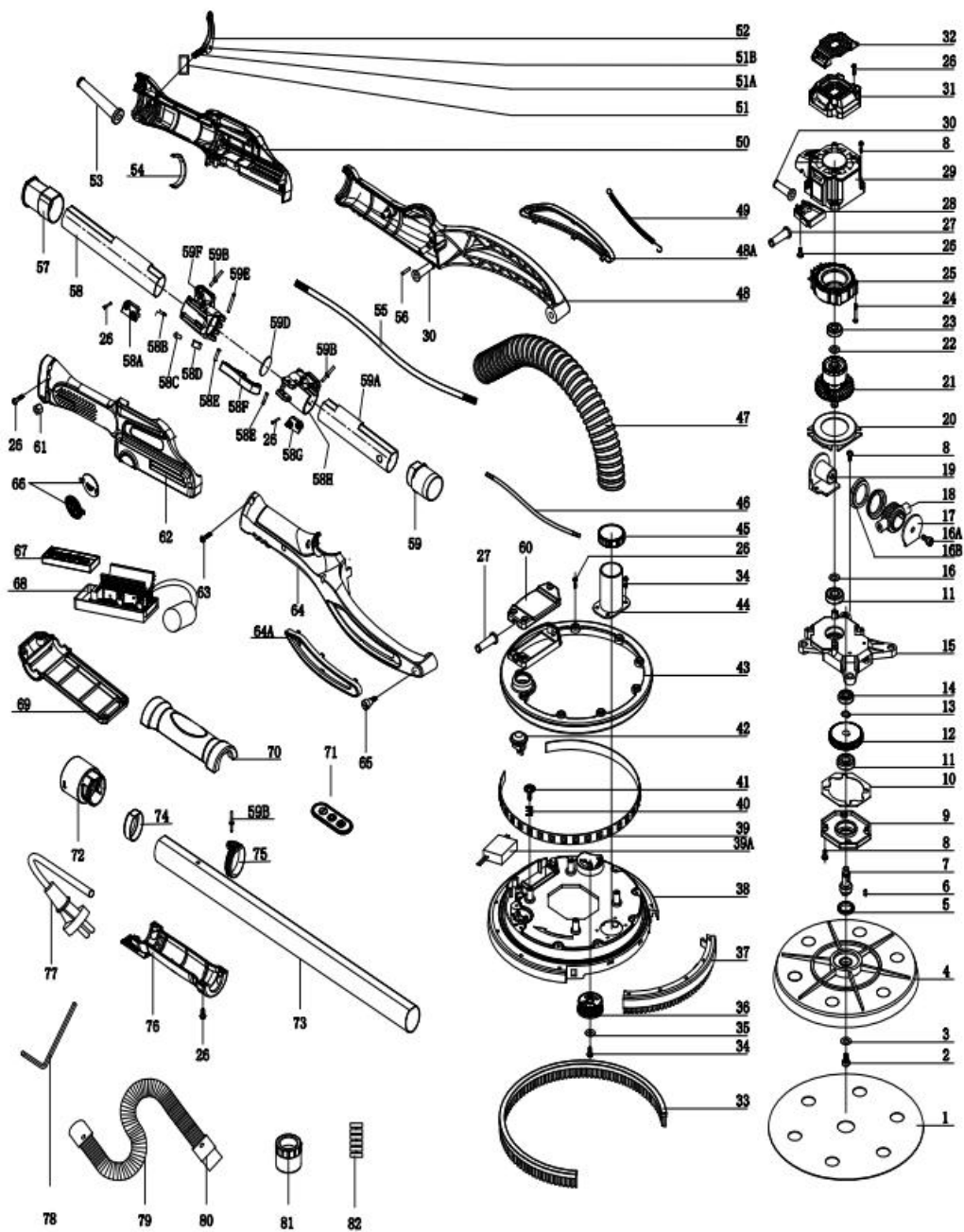

| WS225-KCL Exploded View List | | | | | | | |
|------------------------------|---------------------------------|-----|----------|-----|-------------------------------------|-----|--------|
| No | Part name | Qty | specs | No | Part name | Qty | specs |
| 1 | Self-adhesive sandpaper | 1 | | 48A | Left front handle decorative cover | 1 | |
| 2 | Allen screws | 1 | M6X14 | 49 | Stretch spring | 1 | |
| 3 | Flat pads | 1 | φ6 | 50 | Left main handle | 1 | |
| 4 | Grinding disc | 1 | | 51 | Special flat pad | 1 | |
| 5 | Oil seal | 1 | | 51A | Eccentric wrench threaded pin | 1 | |
| 6 | Flat key | 1 | 3x3x8 | 51B | Eccentric wrench round pin | 1 | |
| 7 | Output shaft | 1 | WS225 | 52 | Eccentric wrench | 1 | |
| 8 | Three combination screws | 10 | M4X20 | 53 | jacket | 1 | |
| 9 | Gearbox cover | 1 | | 54 | Crimping clips | 1 | |
| 10 | Paper pads | 1 | | 55 | Five-core wire | 1 | 1.35M |
| 11 | Ball bearings | 2 | 6000 RS | 56 | Hook-up | 1 | Φ3*16 |
| 12 | Final stage gear | 1 | | 57 | Dust jacket | 1 | |
| 13 | Retaining rings for shafts | 1 | φ10 | 58 | Rear double channel aluminum tube | 1 | |
| 14 | Ball bearings | 1 | 608Z | 58A | Post-rubber sleeve briquettes | 1 | |
| 15 | Gearbox body | 1 | | 58B | Return spring | 1 | |
| 16 | Flat pads | 1 | φ10 | 58C | Adjustment screws | 1 | |
| 16A | Three combination screws | 1 | M6X15 | 58D | Supports | 1 | |
| 16B | Flared mouth damping | 2 | | 58E | Round pin | 2 | |
| 17 | Movable sleeve fixing tab | 1 | | 58F | Lock the wrench | 1 | |
| 18 | Activity set | 1 | | 58G | Front rubber sleeve briquettes | 1 | |
| 19 | Removable sleeve holder | 1 | | 58H | Front rubber sleeve | 1 | |
| 20 | Windshield | 1 | | 59 | Aluminum tube fittings | 1 | |
| 21 | rotor | 1 | WS225 | 59A | Front double channel aluminum tube | 1 | |
| 22 | Flat pads | 1 | φ8 | 59B | rivet | 3 | |
| 23 | Ball bearings | 1 | 608 RS | 59D | Sealing rings | 1 | |
| 24 | Phillips self-tapping screws | 4 | ST3*25 | 59E | Round pin | 1 | |
| 25 | stator | 1 | WS225 | 59F | Rear rubber sleeve | 1 | |
| 26 | Phillips self-tapping screws | 11 | ST4*14 | 60 | Lamp wire connection cover | 1 | |
| 27 | Small sheath | 2 | | 61 | Extension nut | 1 | M6 |
| 28 | Case briquettes | 1 | | 62 | Right main handle | 1 | |
| 29 | Case | 1 | | 63 | Phillips self-tapping screws | 17 | ST4*16 |
| 30 | Small sheath | 2 | 5010 | 64 | Right front handle | 1 | |
| 31 | Chassis back cover | 1 | | 64A | Right front handle decorative cover | 1 | |
| 32 | Dust cap | 1 | | 65 | Threaded pins | 2 | M6 |
| 33 | Double row of brushes | 1 | | 66 | Trademark cover | 2 | |
| 34 | Phillips self-tapping screws | 4 | ST4*10 | 67 | Switch the governor | 1 | |
| 35 | Flat pads | 1 | φ4 | 68 | Line control board | 1 | |
| 36 | Suction regulating wheels | 1 | | 69 | Main handle bottom cover | 1 | |
| 37 | Lateral edges | 1 | | 70 | Upper sub-handle | 1 | |
| 38 | Protective cover | 1 | | 71 | Switch speed control panel | 1 | |
| 39 | Light strips | 1 | | 72 | Dust collection pipe fittings | 1 | |
| 39A | Light strip power | 1 | | 73 | Elliptical tube | 1 | |
| 40 | Compression spring | 4 | φ11.5*24 | 74 | Elliptical tube connection sleeve | 1 | |
| 41 | Large washer combination screws | 4 | ST4X12 | 75 | Elliptical tube positioning sleeve | 1 | |
| 42 | LED switch | 1 | | 76 | Lower sub-handle | 1 | |
| 43 | Cover on the protective cover | 1 | | 77 | Power cord | 1 | |
| 44 | Shield connector | 1 | | 78 | Allen key | 1 | S5 |
| 45 | Hoops | 1 | 25-38 | 79 | Dust collection tube | 1 | |
| 46 | Two-core light wire | 1 | | 80 | Joint | 1 | φ35 |
| 47 | Two-wire vacuum cleaner | 1 | 500 | 81 | Joint | 1 | φ57 |
| 48 | Left front handle | 1 | | 82 | Connect the wire terminals | 1 | |

VEVOR[®]

TOUGH TOOLS, HALF PRICE

Support and E-Warranty Certificate

www.vevor.com/support

Made In China